

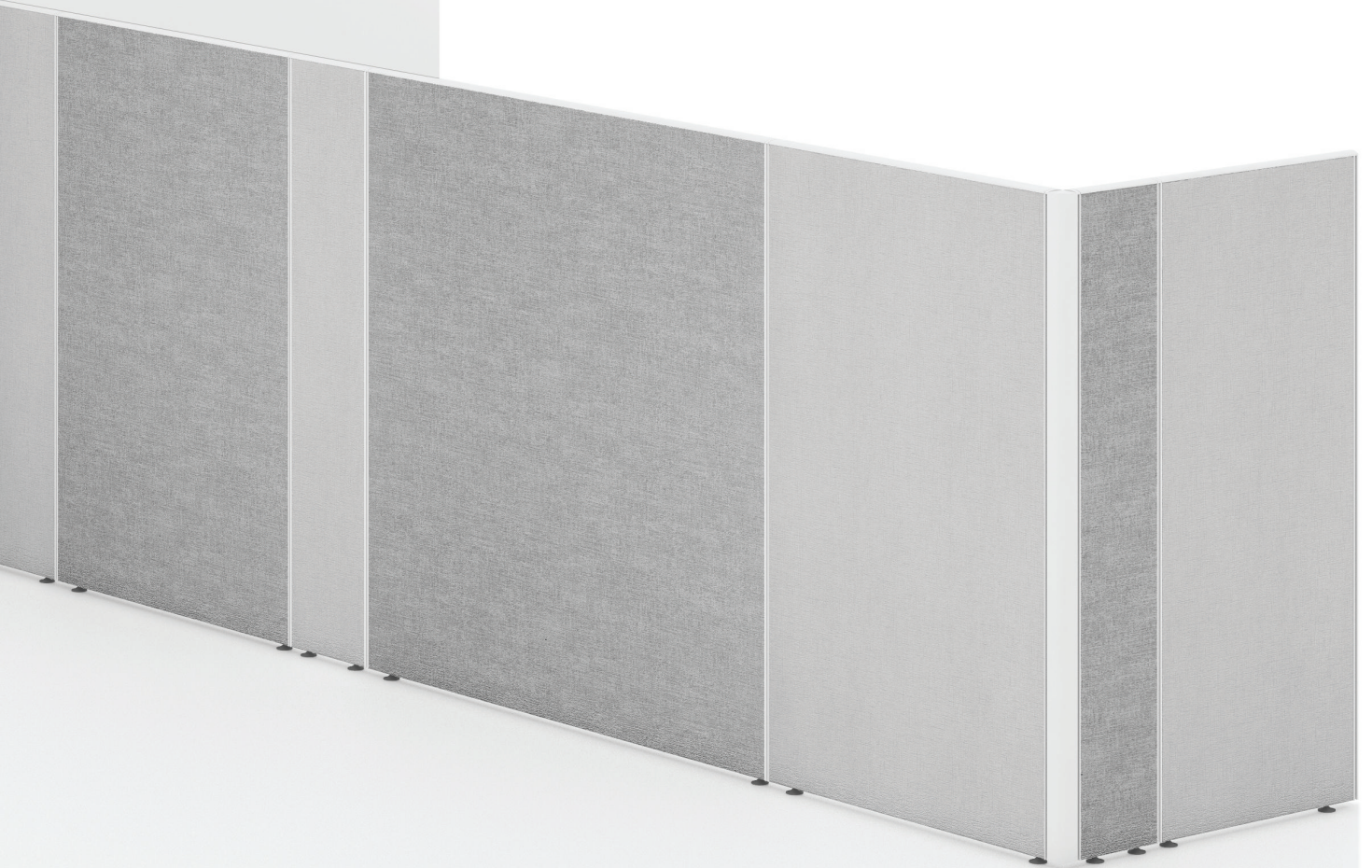

ESSENTIA55

Essentia55 brings modernism and flexibility into the workplace with infinite configuration possibilities. Designed to adapt seamlessly, it creates universal layouts that balance individual focus with collaborative interaction, transforming offices into dynamic, creative environments.

“ Design is a plan for
arranging elements
in such a way as best
to accomplish a particular
purpose. ” Charles Eames



Essentia55

Hot Desk

Essentia brings modernism and spatial flexibility to life through the seamless integration of inspiring ideas. It redefines the workplace by offering universal, creative layouts and virtually limitless configuration possibilities, giving true freedom in shaping space.

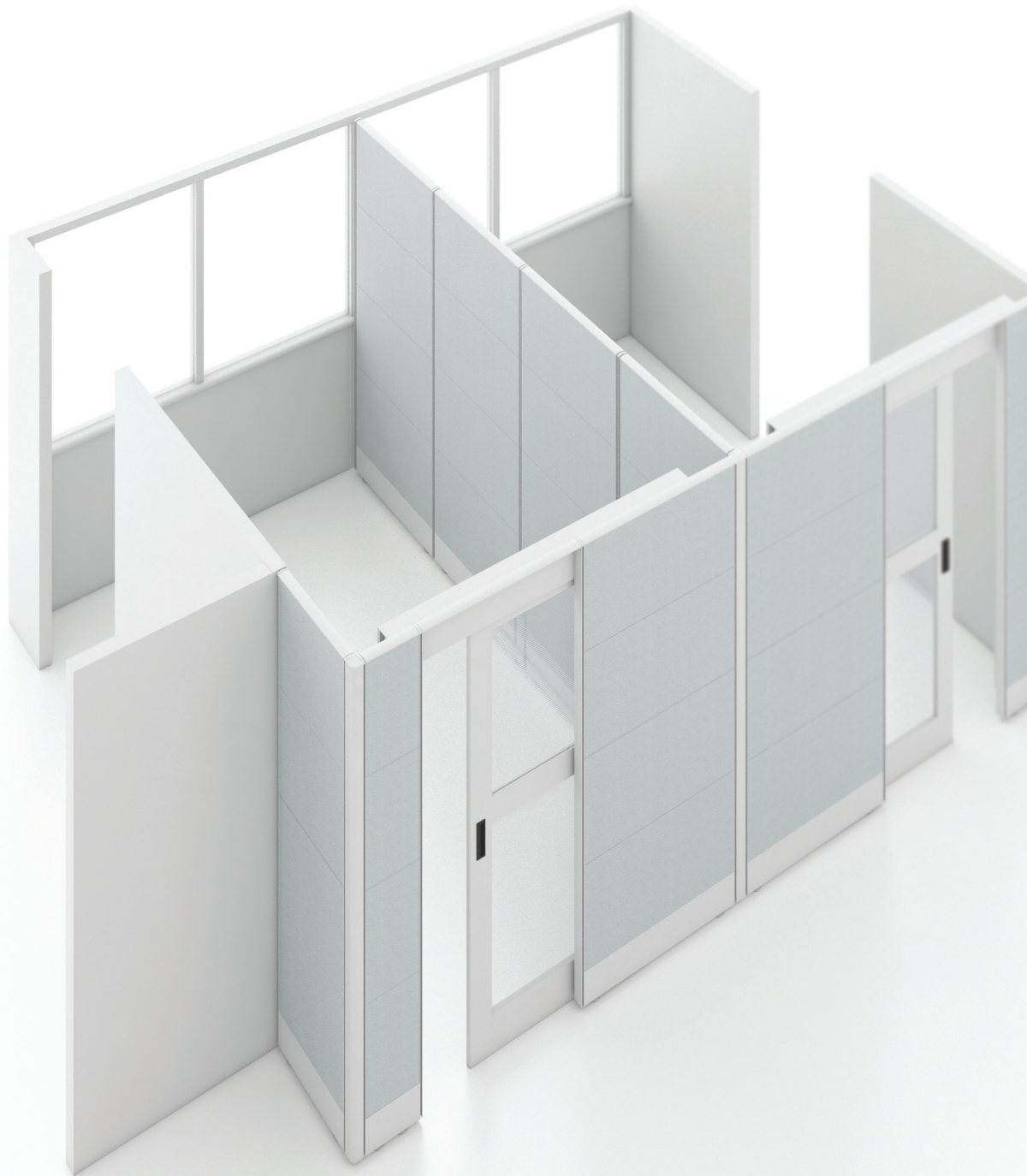



Essentia55

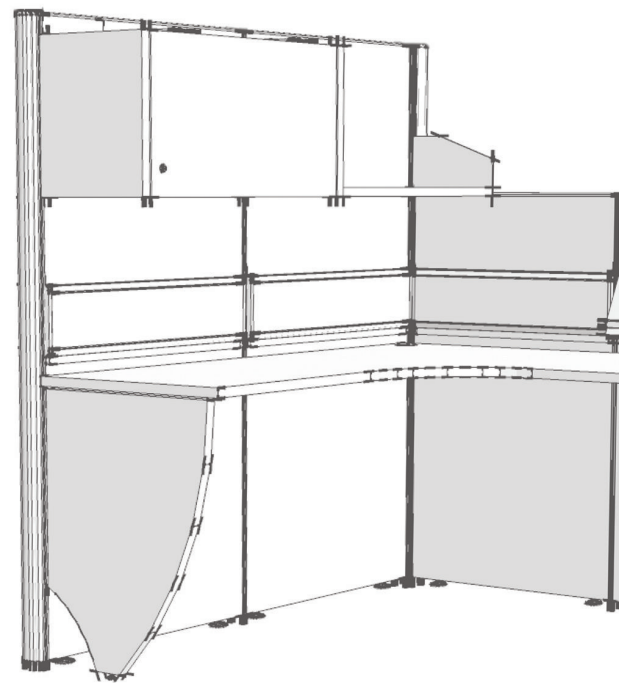

High Workstation

A practical mid-height system (1250mm–1650mm), designed for senior executives, offering the perfect balance of privacy while maintaining visual connectivity within the workspace.



EXPOSED WIRE MANAGEMENT



CONCEALED WIRE MANAGEMENT



BOTTOM WIRE MANAGEMENT





METAL HANGING CABINET



METAL HANGING CABINET - OPENED



High Cluster Workstation

Essentia delivers a high-performance cabinet with generous storage capacity, supporting focused work styles. It creates a semi-private, enclosed workspace while offering a convenient and user-friendly storage solution.



WOODEN HANGING CABINET



ACCESSORIES RAIL



MOBILE PDESTAL



E S S E N T I A 5 5



Multiple connection options 90°, 120°, straight, and cross panels, allow versatile configurations, while adjustable drop heights enhance flexibility for any workspace. Accessories such as overhead bins, stationery trays, pencil holders, and telephone trays can be mounted on accessory tiles, providing ergonomic organization and freeing valuable tabletop space. These features allow you to easily expand or reduce your setup, enabling various layout options for open-plan offices or private cabin environments.



General Workstations

A new concept of workstations created with the aim of a simple yet dynamic functionality. Essentia's compact elements are matched together to provide the answer with functional attributes; they reduce components and give the opportunity to make infinite modular configurations.

Discussion

Embody the evolution of workplace culture, where communication is key. The meeting space fosters the sharing of ideas in an environment that strikes the perfect balance between personal space and collaborative interaction.



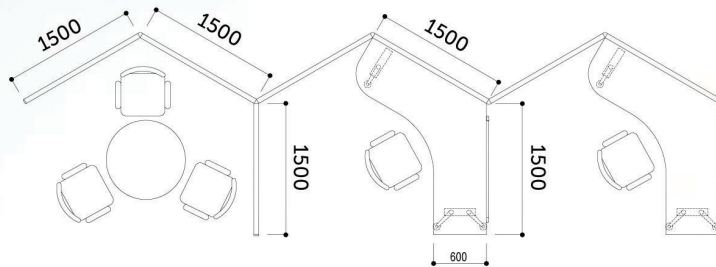

The purposeful storage area is thoughtfully designed to maximize space while preserving the overall aesthetic of the furnishings, with cabinets that also function as partition walls.

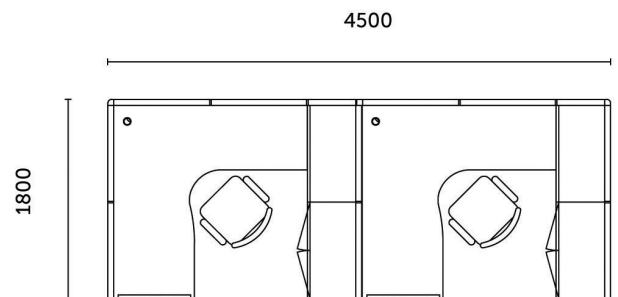

PANEL SEGMENT



TILE SEGMENT



METAL TRIM SEGMENT

THE JOINS



180 DEG PROFILE



3 WAY CONNECTOR



2 WAY CONNECTOR



4 WAY CONNECTOR

WIRE MANAGEMENT



EXPOSED POWER SOCKETS & CONCEALED POWER SOCKETS

MAINTENANCE GUIDE - FINISHES CARE AND MAINTENANCE

To maintain the finish quality of our Essentia System, please follow the cleaning procedures provided below. With regular care and maintenance, the C&R furniture will provide years of superior performance and satisfaction.

The instruction for the care and maintenance are provided to you as a service. No warranty is implied since results vary.

POWDERCOATED METAL

For normal cleaning, wash coated metal surfaces with a soft cloth soaked in detergent and warm water; rinse thoroughly and dry. Remove scuff marks from low-gloss coatings with pre-softened paste wax, following the manufacturer's instructions.

For assistance in determining the appropriate colour and gloss for touch up paint, please contact C&R personnel.

POLY-CARBONATE / ACRYLIC PANELS

For normal cleaning, first rinse the surface with clean water to remove any particles of dust or other abrasive materials. Sponge the plastic gently with warm water and a mild, nonabrasive soap or a solution of ammonia and water. Rinse thoroughly with clean water and dry with a soft cloth. After cleaning, the polycarbonate can be polished with a good wax polish applied with a clean, soft flannel pad.

Do not use benzene, acetone, denatured alcohol, or gasoline. These solvents soften the surface of the plastic and may cause damage. Also avoid using glass cleaning compounds, abrasive cleaners, and hard instruments. Make sure cleaning materials are free of grit and other foreign materials.

GLASS

For normal cleaning, use products specifically designed for glass

PLASTIC

For normal cleaning, wash plastic surfaces with a soft cloth soaked in mild detergent and warm water. Rinse thoroughly and drop with a soft cloth. Do not use solvents or abrasive kitchen cleaners.

MELAMINE / LAMINATES

Products using melamine and laminate include tabletops, work surfaces, counter tops, overhead cabinets, filing cabinets. For normal cleaning, wash melamine and laminate with a soft cloth and a solution of mild detergent and warm water. Rinse thoroughly and dry with a soft cloth.

For minor report of burns or other stubborn marks, apply a nonabrasive liquid kitchen cleanser with a soft cloth soaked in warm water. Rub in the director of the grain; use caution to avoid damaging the surface texture or gloss. If no grain direction is visible, rub with a light, in circular motion.

Do not use powdered abrasives or other harsh cleansers like hypochlorite bleach, hydrogen peroxide, nitric or hydrochloric acids, or lye, they may deface the surface and change the finish colour.

POLISHED ALUMINIUM

For normal cleaning, apply a pre-soften paste wax to polished aluminium components following the manufacturer's instructions. In humid atmospheres near salt water, apply the wax once a month. In other areas, apply wax evenly three months to maintain the appearance of the aluminium.

System Components

PANEL HEIGHT

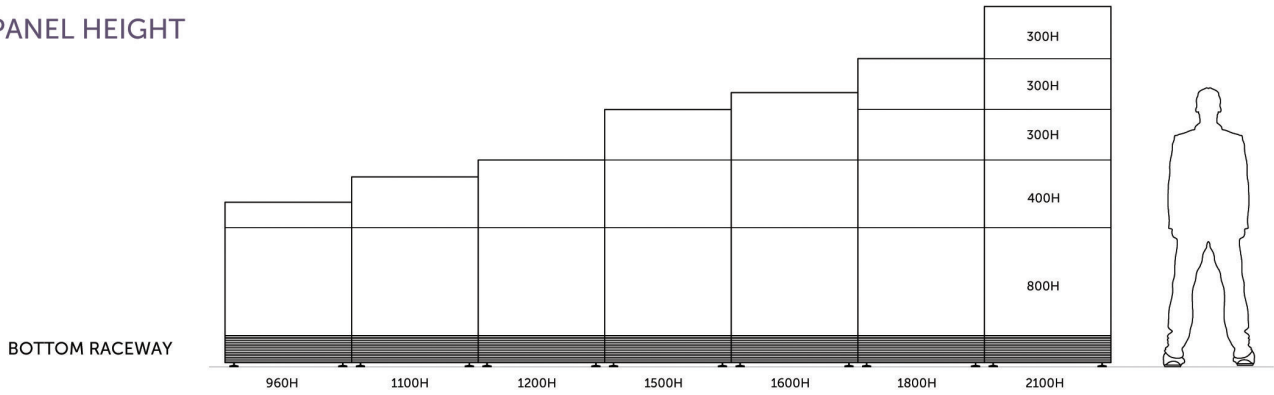

MID - RACEWAY

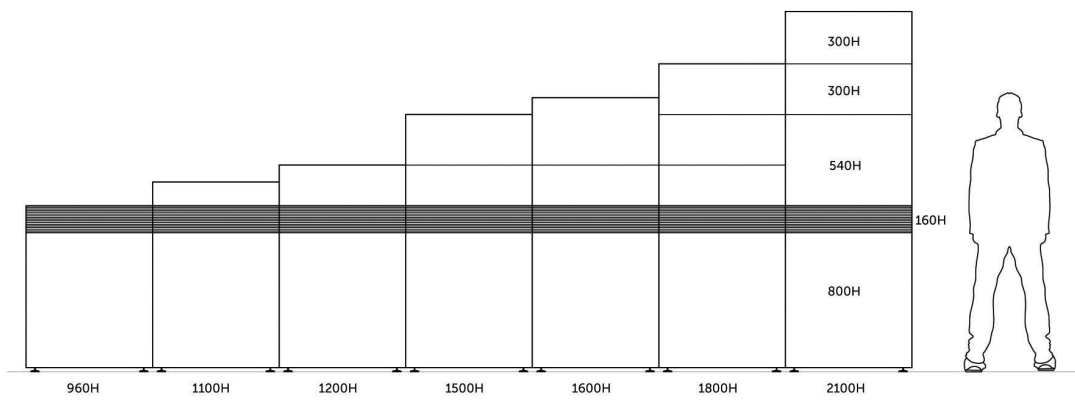

PANEL WIDTH

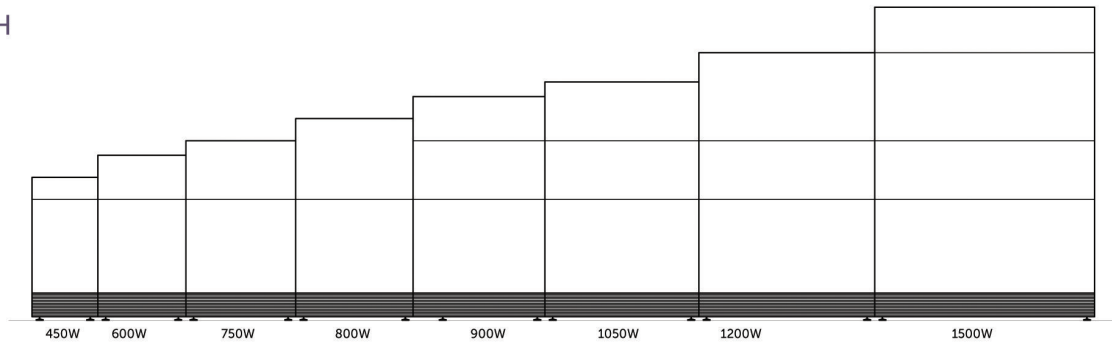

PANEL FINISHES

FABRIC



ACCESSORIES

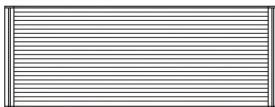

WHITE BOARD



LAMINATE

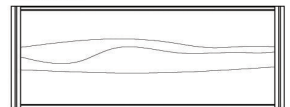

POLYCARBONATE

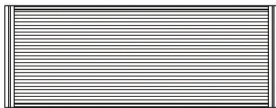

GLASS



FABRIC/ PINBOARD

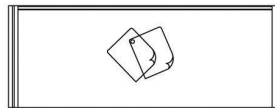

MFC

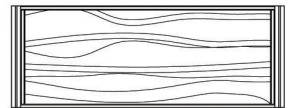

RACEWAY SYSTEM

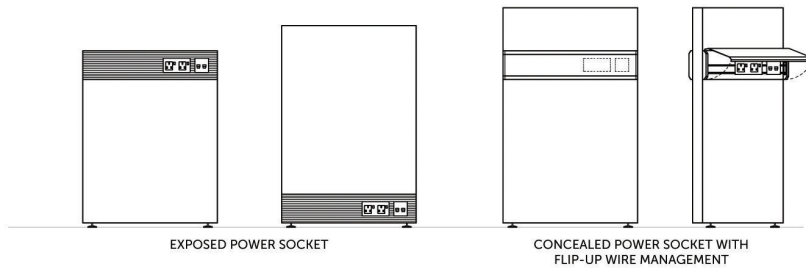

PANEL SEGMENT

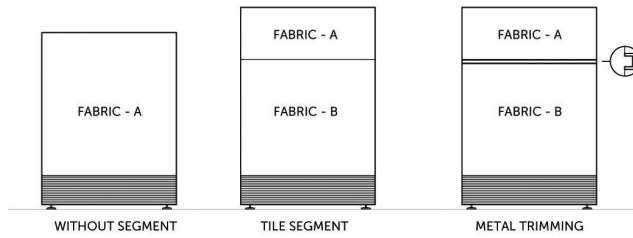

CONNECTOR

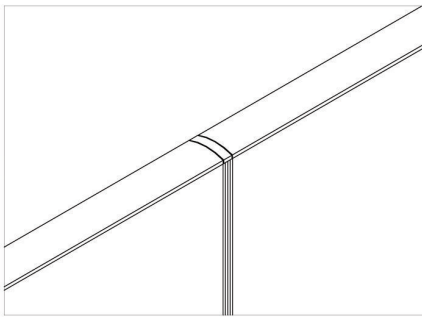

180° CONNECTOR

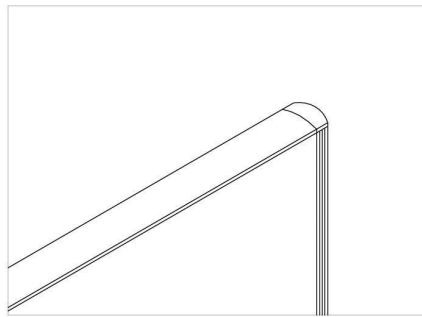

END-CONNECTOR

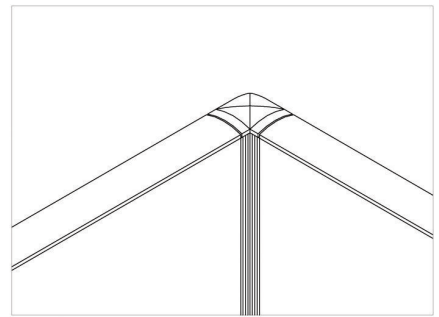

2-WAY CONNECTOR

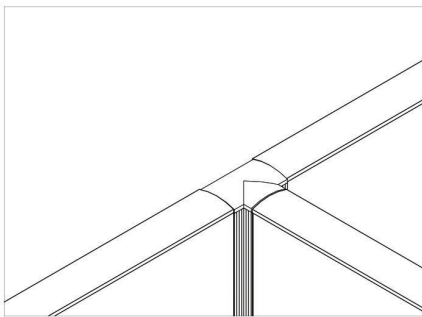

3-WAY CONNECTOR

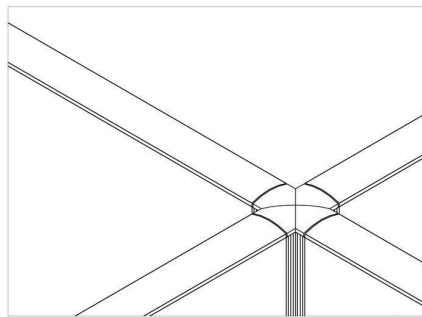

4-WAY CONNECTOR

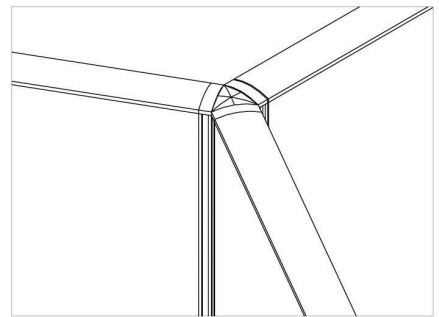

120° CONNECTOR

TABLE EDGING

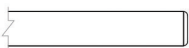

FLAT EDGE

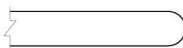

POST FORM

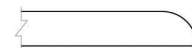

DUCK NOSE



REVERSED WATERFALL



CHAMFER WATERFALL



TWO-TONED EDGING

System Components

SWING DOOR/ SLIDING DOOR/ OPEN SHELF

HEIGHT:
750 H
900 H
1200 H
1800 H
2100 H
2400 H

LENGTH:
450 L
500 L
600 L
750 L
900 L

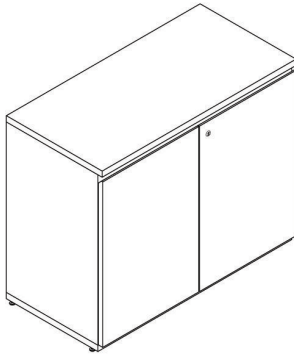

SWING DOOR CABINET

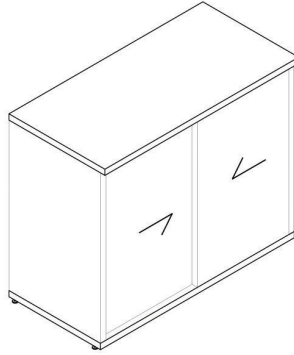

SLIDING DOOR CABINET

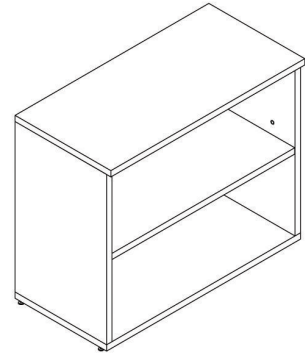

OPEN SHELF

MOBILE PEDESTAL

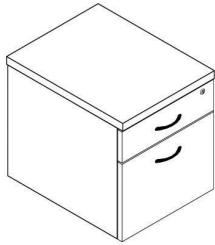

1D + 1F

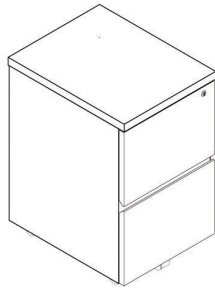

2F

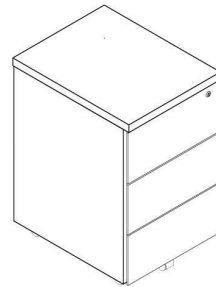

3D

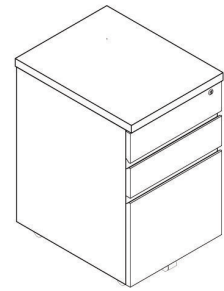

2D+1F

HEIGHT:
1D1F 560MM/2D1F 690MM/2F 690MM/3D 690MM

DEPTH:
510

WIDTH:
410

OPTIONAL:

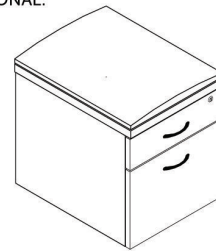

CUSHION TOP

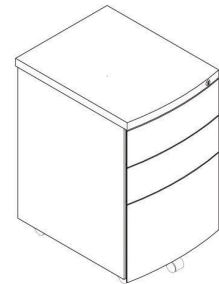

METAL PEDESTAL / SINGLE SIZE
(640H X 410W X 540D)

COMPOSITE STORAGE

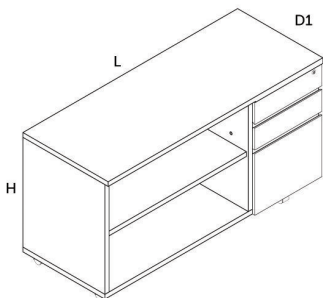

OPENSHELF/ 2D1F MOBILE PEDESTAL

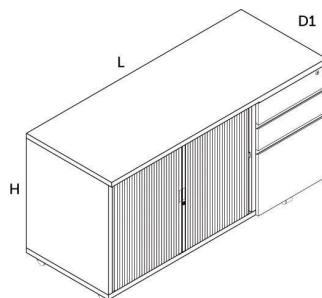

TAMBOUR DOOR/ 2D1F MOBILE PEDESTAL

HEIGHT:
690 H

LENGTH:
800L/ 900L/ 1000/ 1200

D1:
450/ 510

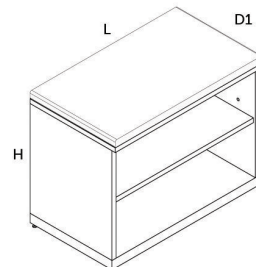

OPENSHELF (WITH OPTIONAL TOP CUSHION)

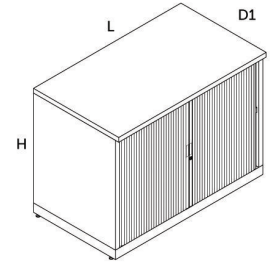

TAMBOUR DOOR CABINET

HANGING CABINET/ OPEN SHELF

HANGING CABINET

LENGTH:
600L/ 700L/ 750/ 800L/ 900L

D1:
350 WOOD
D1:
380 METAL

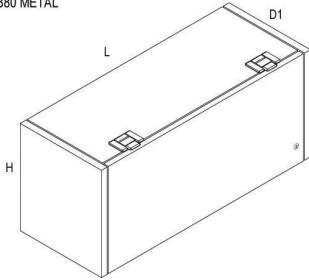

WOODEN HANGING CABINET

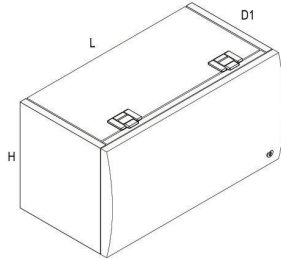

METAL HANGING CABINET

HANGING OPEN SHELF

LENGTH:
600L/ 700L/ 750/ 800L/ 900L

D1:
300

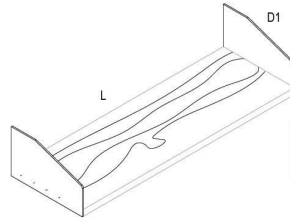

WOODEN HANGING SHELF

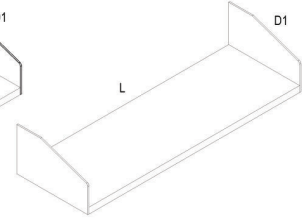

METAL HANGING SHELF

LAYOUT CONFIGURATION

1-CLUSTER



1-CLUSTER

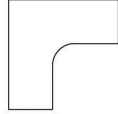

1-CLUSTER



4-CLUSTER

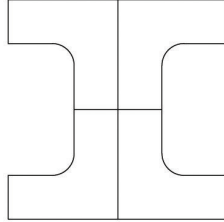

1-CLUSTER/
OUTWARD FACING

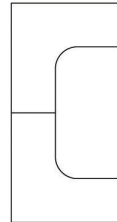

4-CLUSTER/ STACKED

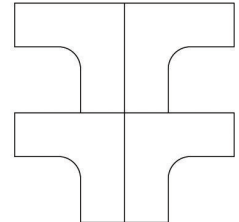

2-CLUSTER



2-CLUSTER/
INWARD FACING

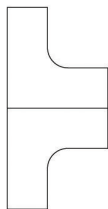

3-CLUSTER/
COMBINATION

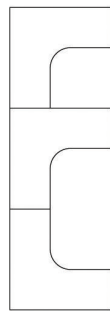

4-CLUSTER/
INWARD FACING



4-CLUSTER/
INWARD FACING

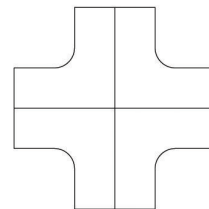

3-CLUSTER/ 120°

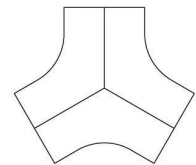

4-CLUSTER/ SPIRAL

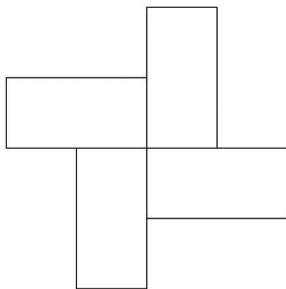

2-CLUSTER/ STACKED

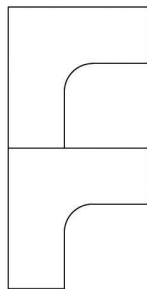

4-CLUSTER/ DIAGONAL INWARD FACING

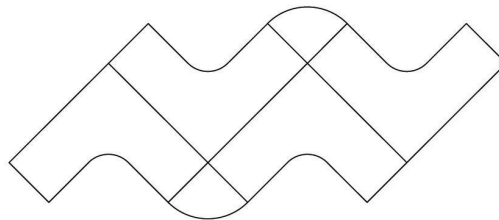

DISMANTLING INSTRUCTION FOR RECYCLING (WORKSTATIONS)

These instructions apply to all workstation products.

DISMANTLING

Components need to be broken down by material content and separated appropriately in order to maximize recycling. Setup a well-lit work area with benches and all necessary tools. Power tools are required for most jobs but some simple hand tools can handle the smaller jobs. Screw and nut with the appropriate bits are the most frequently used. Materials can be identified by using the chart below. Bins and boxes will be needed for each material.

WORKSURFACES

Laminate worksurfaces should have edge trim removed for recycling where possible. Locate the seam on the edging, pry out with straight screwdriver and peel off.

ACCESSORIES

Lighting and electrical accessories need further disassembly. Bulbs, ballasts and other electrical components must be separated for appropriate disposal. Wiring can be removed and recycled. Other accessories can be broken down and separated by material by removing visible fasteners.

PEDESTALS, LATERALS AND CABINETS

For steel cases, remove drawers by lifting up and out. Remove drawer fronts by removing attachment screws if fronts are different material. Remove any added handles. Remove slides (lift up and forward) and any small plastic parts from case interiors. Remove plastic casters from bottom of cases.

For wood cases, remove drawers by lifting up and out. Remove drawer fronts by removing attachment screws if fronts are different material. Remove any added handles. Unscrew slides and other metal brackets and parts from case, including locks and levelers. Hinged doors are removed by unfastening hinges and removing hardware.

OVERHEAD STORAGE

Remove doors by removing visible screws. Remove any added handles. Remove door mechanism and any brackets. With wood cabinets, dismantle any steel components. Steel cabinets do not usually need to be further broken down.

SCREENS

Once Mini screens are removed from furniture, screen material should be removed from its frame and hardware. Fabric screens should have the fabric removed by locating an edge and peeling off. Screens with glass in frames can be disassembled by removing screws and carefully sliding glass out. Once aluminium extrusions are identified, any cap at ends or corners should be removed by tapping sharply with hammer (press fit). Pray off and end caps, trim caps and separate materials. Accessory rails and whiteboard are handle in a similar manner.

Contact Us

SINGAPORE

SINGAPORE REGIONAL HEADQUARTERS
C&R Interiors Pte Ltd
20 Joo Koon Crescent Singapore 629020
T: +65 6488 0577
E: admins@cnrinteriors.com.sg

SINGAPORE

SINGAPORE FLAGSHIP SHOWROOM
C&R Interiors Pte Ltd
100 Pasir Panjang Road
#01-01 Singapore 118518
T: +65 6372 0428 F: +65 6255 4288

MALAYSIA

MALAYSIA SHOWROOM
C&R Interiors Sdn Bhd
#10-10, 10th Floor, Wisma UOA II,
No.21, Jalan Pinang, 50450
Kuala Lumpur, Malaysia.
T: +603 2701 3668
E: project-my@cnrinteriors.com

THAILAND

THAILAND SHOWROOM
C&R Office Furniture Co Ltd
O-NES Tower, 19th Floor, Unit 4
6 Sukhumvit Soi 6, Klong Toey
Bangkok, 10110, Thailand
T: +66 2078 1949
E: marketing@cnrthailand.com

CHINA

Guangzhou C&R Sendas Co., Ltd
Room 101, Building 1, No. 6,
Dashadi West, Huangpu, District
Guangzhou, Guangdong Province, China
T: +86 1821 1331 534
E: marketing@sendaspace.com

